

User Manual

MS-22S9SB

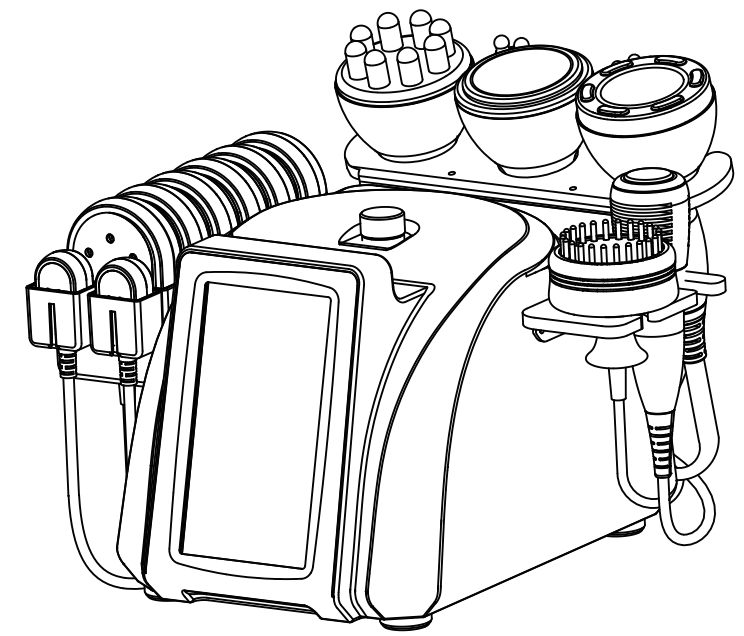

Content

1.Safety Precautions	1
2.Contraindications	1
3.Overview	2
4.Interface Introduction	3
5.Technical Specification	10
6.Use Precautions	11
7.Maintenance & Cleaning.....	12
8.FAQ	13
9.Ask & Answer	16
10.Operation Guide	18
11.Warranty & Support.....	21

1.Safety precautions

- 1.Please read this manual carefully before use and familiarize yourself with the operation of this instrument and related technology.
- 2.This instrument is a high-precision electronic device that requires proper storage. Please avoid storing it in humid conditions, direct sunlight, or near flammables and explosives to prevent damage.
- 3.Always use the designated accessory provided or recommended by the manufacturer to ensure performance throughout its service life.
- 4.Do not place the instrument in high-temperature conditions, as this may negatively impact its service life and performance.
- 5.Do not apply the instrument on eyes, thyroid, parathyroid, testicles, pregnant women's abdomen, pacemakers, etc.
- 6.Patients should refrain from using this instrument unless they have obtained permission from their doctor.
- 7.Ensure that the instrument is applied on moist skin and avoid the operation on dry skin.
- 8.Power off the instrument when not in use to ensure its safety.
- 9.If you are currently taking anti-adiposity drugs, please discontinue their use for 1 - 2 months before using this instrument. Failure to do so may result in an extended course of treatment.
- 10.To maintain hygiene and extend the instrument's service life, sterilize it with saline.

2.Contraindications

Before using this instrument, it is essential to consult your doctor or seek advice from professionals. Details below:

- 1.Pregnancy or lactation.
- 2.Hypertension, heart disease, or with a pacemaker installed.
- 3.Unhealed wounds or during the recovery phase of surgery.
- 4.Epilepsy, severe diabetes, and hyperthyroidism.
- 5.Malignant tumors, hemophilia, and hemorrhage.
- 6.Skin disease or infectious disease.
- 7.Cesarean section within the last six months, a miscarriage within the last three months, or a natural birth within the last two months.
- 8.Had plastic surgery within 3 months or with implants or metal objects in the treatment area.
- 9.Sensitivity to microcurrent.

3.Overview

With the most popular and safest technology for anti-aging, firming skin, and body shaping, this 8-in-1 beauty instrument ensures you achieve your desired body figure. It provides the perfect solution for people seeking improvements in skin appearance and body figures without injections, drugs, or side effects. Its external application yields immediate results.

4.Interface Introduction

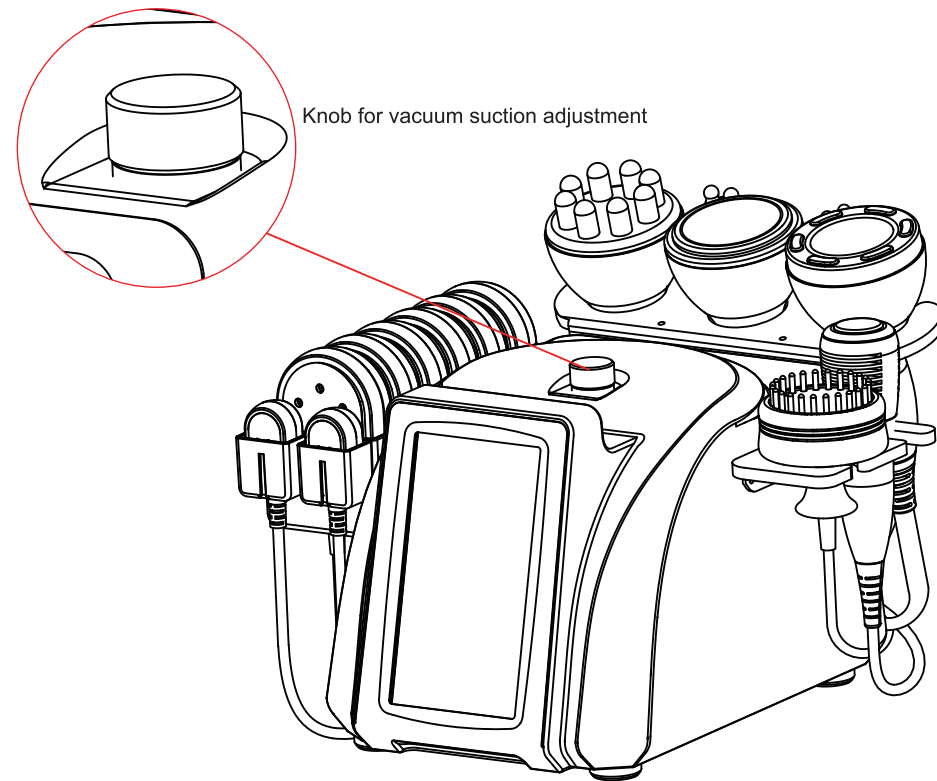

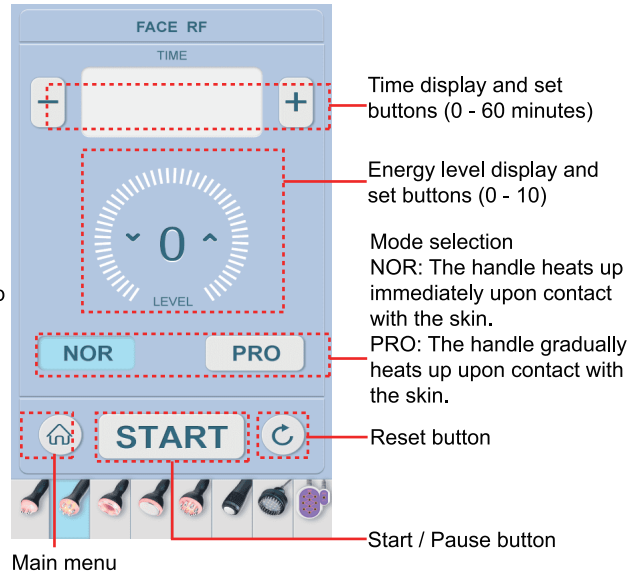
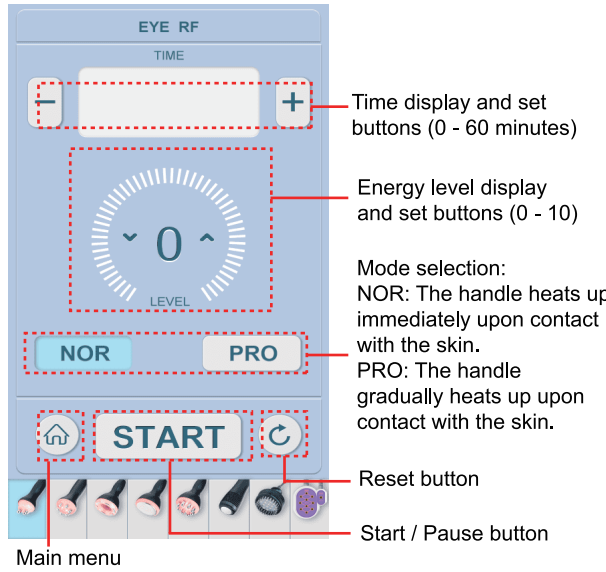
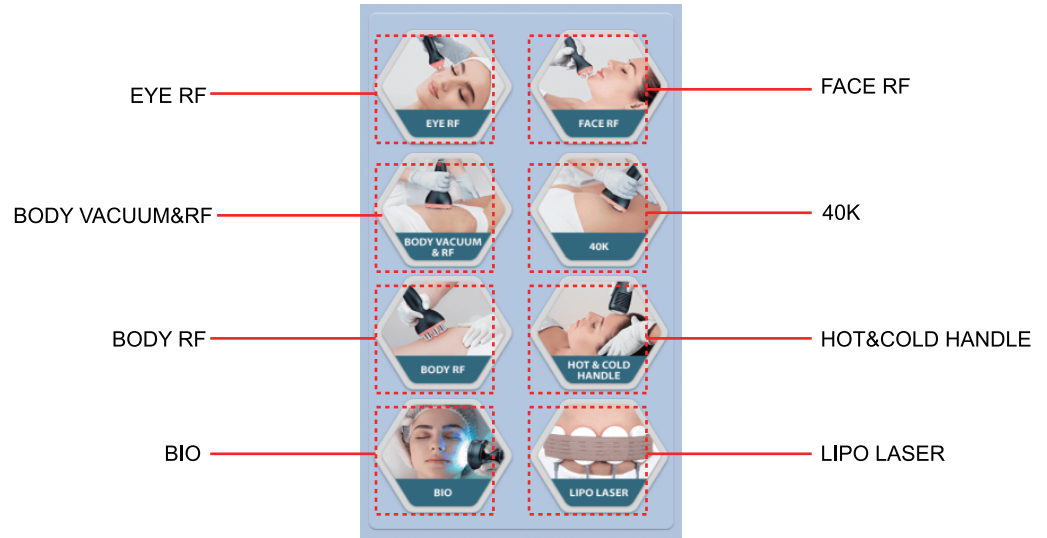

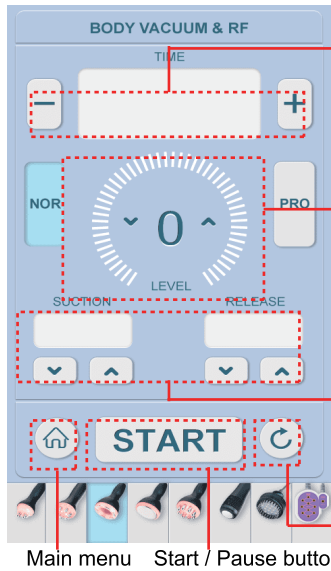

Time display and set buttons (0 - 60 minutes)

LEVEL: energy level display and set buttons (0 - 10)

Mode selection:
 NOR: The handle heats up immediately upon contact with the skin.
 PRO: The handle gradually heats up upon contact with the skin.

SUCTION: Suction time display and set buttons
 RELEASE: Release time display and set buttons

Start / Pause button

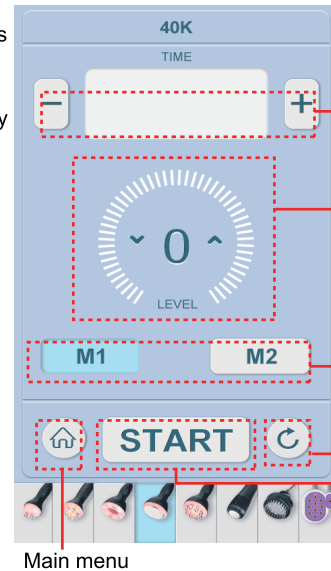

Time display and set buttons (0 - 60 minutes)

Energy level display and set buttons (0 - 10)

Mode selection:
 M1: Continuous working mode
 M2: Intermittent working mode

Reset button
 Start / Pause button

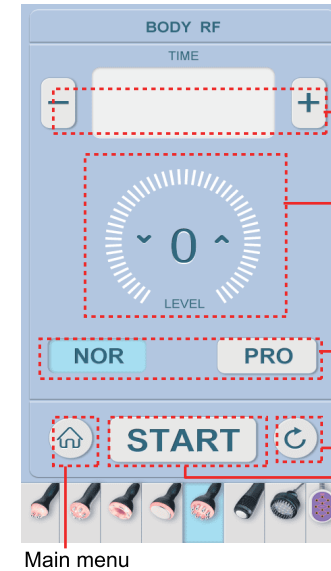

Time display and set buttons (0 - 60 minutes)

Energy level display and set buttons (0 - 10)

Mode selection:
 NOR: The handle heats up immediately upon contact with the skin.
 PRO: The handle gradually heats up upon contact with the skin.

Reset button
 Start / Pause button

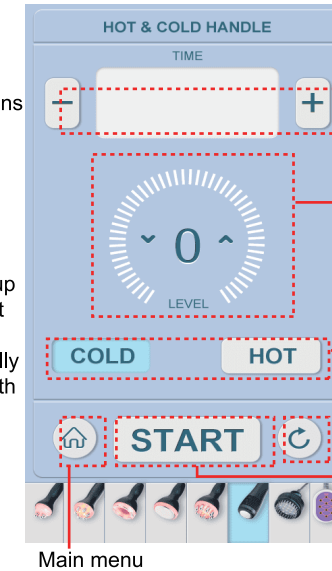

Time display and set buttons (0 - 60 minutes)

Energy level display and set buttons (0 - 10)

Mode selection:
 COLD: Activate the cold mode.
 HOT: Activate the hot mode.

Reset button
 Start / Pause button

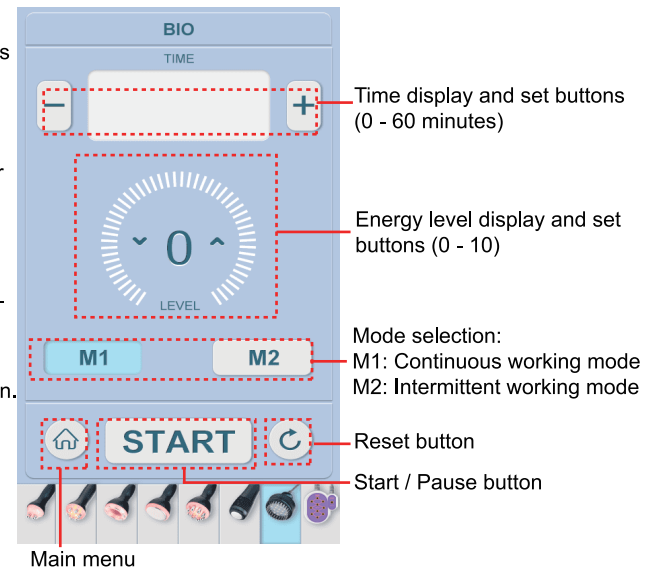
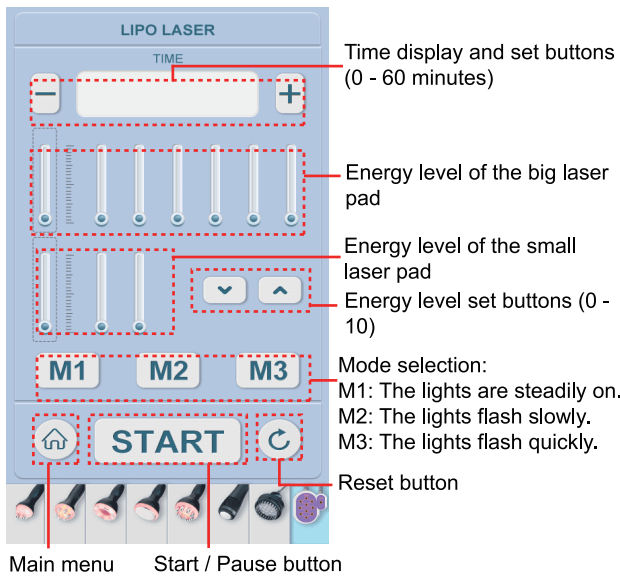

Microcurrent and Photon Handle

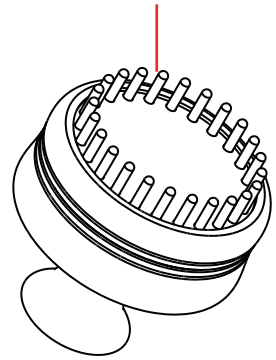



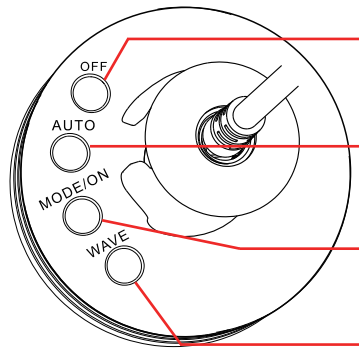
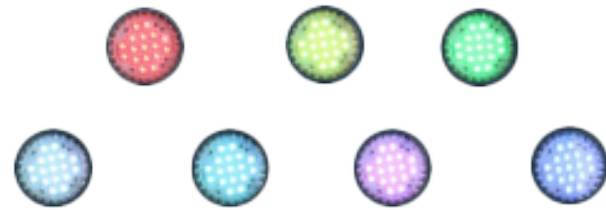



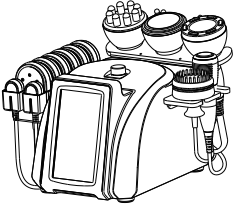

7 Colors 17 LEDs



- OFF: Photon LED
- AUTO: Automatic alteration of color (cycle through multiple twinkling colors)
- MODE/ON: Mode selection (different colors can be chosen to stay on)
- WAVE: Mono twinkling color (click on MODE to change to different color when needed.)

5. Technical Specification

	Power supply Input: 110V-220V 50HZ/60HZ		Net Weight: 8.27 KG		
	Power: 79 W		Gross Weight: 9.32 KG		
	Dimensions: 14.1 × 11.8 × 11inches				
	Input Power: 79 W				
	Frequency:40K Hz Power: 30 W		Frequency: 1 MHz Power: 70 W		Frequency: 1 MHz Power: 54 W
	Frequency: 1 MHz Power: 30 W		Wavelength: 650 nm5mw Power: 15 W		
	Frequency:40K Hz Power: 79 W Vacuum: -78KPa	Air flow: 7 LPM Noise level: <65 db(30cm away)			
	Cooling power/heating power: 20W Cold: 32-39.2°F Hot: 113°F		Frequency: 62.5 Hz Power: 11 W		

6. Use Precautions

1. Strictly follow the instructions in the manual to use the instrument and train operator.
2. Before using the instrument, use a plug with a grounding pin and ensure the power socket is grounded.
3. Make sure the voltage of the instrument is adapted. If the local power supply voltage is unstable, we recommend adding a power-matched regulated power supply between the mains and the instrument.
4. Remove all the metal objects inside the body to avoid causing accidents or affecting treatment effects.
5. Stop the intake of anti-adiposity drugs 1 - 2 months before the treatment, or extend the treatment course if you want to take the treatment immediately.
6. Refrain from using the instrument on an empty stomach, and initiate the treatment one hour after a meal.
7. Ensure full skin contact with the treatment head throughout the session to avoid uneven heat distribution.
8. Refrain from using the 40K handle on areas such as the head, chest, breast, heart, or back.
9. Always start with the lowest suction intensity, and increase it gradually.
10. Ensure the filter cotton is installed inside the vacuum handle, as the foreign body may block the handle.
11. Fix the laser pads on the treated individual first, then switch on the instrument, and gradually adjust the energy intensity from low to high to ensure a warm and comfortable experience for the user.
12. Maintain complete contact between the laser pad surface and skin, avoiding partial contact.
13. The combination of the laser pad with massage or other beauty devices contributes to better

results. Alternatively, you can use the laser pads alone. Simply fix them in the treatment area and wait for 20 minutes.

14. During Hot&Cold treatment try to avoid air vents, as the bad heat dissipation may affect the service life of the instrument.

Before beginning the microcurrent treatment, kindly inform the customer about the sensations associated with microcurrent to prevent any unnecessary concerns or discomfort.

7. Maintenance & Cleaning

1. Disconnect the power cord when not in use and store the instrument in a dry, cool, and well-ventilated place.

2. Clean and sanitize the applicator with a damp cloth or saline, and then dry it thoroughly with a dry towel to ensure it remains dry.

3. Before cleaning the Vacuum & RF applicator, ensure to remove the filter cotton to prevent the growth of bacteria.

4. After cleaning the instrument, cover it with a dustcloth or plastic wrap. Before use, ensure to sanitize the handle again for hygienic reasons.

5. Disassembling the instrument and attempting to clean the inside is strictly prohibited. This task should only be performed by professionals.

8. FAQ

1. How long does it take to see the results of RF treatment?

A: You might experience skin tightness right after the treatment, as the heat stimulation tightens the collagen tissue, and the RF stimulates the subcutaneous tissue bringing the continuous regeneration of collagen, leading to more noticeable results within one week.

2. Is RF safe for the skin?

A: RF firming and anti-wrinkle treatment is a non-surgical method that stimulates collagen regeneration and metabolism in the deeper layers of the skin without causing any harm. It's normal to experience temporary heat and redness in the treated area, which indicates increased circulation and should subside within a few hours. There's no need to be concerned about this reaction.

3. What is the duration of a body sculpting treatment?

A: Approximately 60 minutes, our skilled techniques and advanced instrument guarantee impressive results.

4. Liposuction or this device?

A: Liposuction surgery utilizes negative pressure to remove adipose tissue accumulations from specific areas, resulting in a body-shaping effect. It provides you with immediate results, but it also carries risks, requires anesthesia, and involves downtime. While our device offers a risk-free solution with no side effects. It sculpts your body, stimulates collagen regeneration for lifted skin, and creates the ideal figure for an overall improved appearance.

5. Is it safe to use ultrasound on the entire body?

A: NO. Ultrasound disrupts adipose tissue, which is then absorbed and metabolized by the human body. The power of ultrasound is quite strong, and the heart is particularly sensitive to sound waves due to being a hollow organ. Sound waves can cause vibrations in the heart, and there can be variations in how sound waves are conducted through muscle tissue and blood within the heart, resulting in back-and-forth reflections. As a consequence, the valve may become dislodged from the heart muscle. Certainly, ultrasound treatment should be strictly avoided around the eye area to prevent the risk of retinal detachment, as well as areas such as the waist, back, chest, and the region around the heart.

6. Are there any side effects of ultrasound on the human body?

A: The ultrasound treatment is a non-surgical, non-invasive procedure that requires no incisions or anesthesia. It combines various technologies, including ultrasound (mechanical wave), cavitation, and ultrasound focusing. This procedure delivers multiple benefits such as breaking down adiposity, dissolving adiposity, tightening the skin, and sculpting the body. It selectively targets low-density adipose tissue while safeguarding high-density tissues like blood vessels and nerves, ensuring no adverse effects on the body. You may notice a slight noise in your ears during the treatment, which is a normal occurrence and requires no cause for concern.

7. Why do I get tinnitus during the treatment?

A: When the ultrasound with concentrated energy vibrates strongly and has a frequency higher than 20KHz, it can penetrate the skin to reach the adipose layer that is 20mm deep. The energy causes high-speed friction and heat within the adipose tissue, which breaks them down and emulsifies them. However, this process can create noise that may be audible in your ears.

8. What is collagen?

A: Collagen is a biological polymer substance, a white opaque fibrous protein without branched chains, which can replenish essential nutrients needed by all layers of the skin and enhance the collagen activity in the skin, with the effects of locking moisture, moisturizing the skin, delaying aging, improving facial laxity and hair care. Collagen is an essential nutrient for promoting anti-aging effects. As you age, the gradual loss of collagen in your skin becomes evident. Typically, a woman's skin starts showing signs of aging around the age of 20 due to collagen depletion, and the rate of loss peaks at 25. Research suggests that by the age of 40, collagen levels are only about half of what they were at 18. The reduction in collagen and moisture content can contribute to the development of facial folds and wrinkles. This is primarily due to the breakdown of collagen fibers and elastic networks that support the skin. This loss also leads to oxidation, atrophy, and collapse of skin tissue, resulting in various signs of aging such as dehydration, wrinkles, looseness, and lack of elasticity.

9. Will Laser Lipolysis treatment lead to rebound effects?

A: The number of adipose cells in an adult remains constant, and weight gain is typically due to an increase in the size of these cells. This treatment employs a specific laser to stimulate adipose cells, leading them to release stored fatty acids and triglycerides, thereby reducing cell volume. Consequently, the occurrence of fat returning is highly unlikely. Additionally, maintaining a healthy diet would greatly contribute to preventing it.

9. Ask & Answer

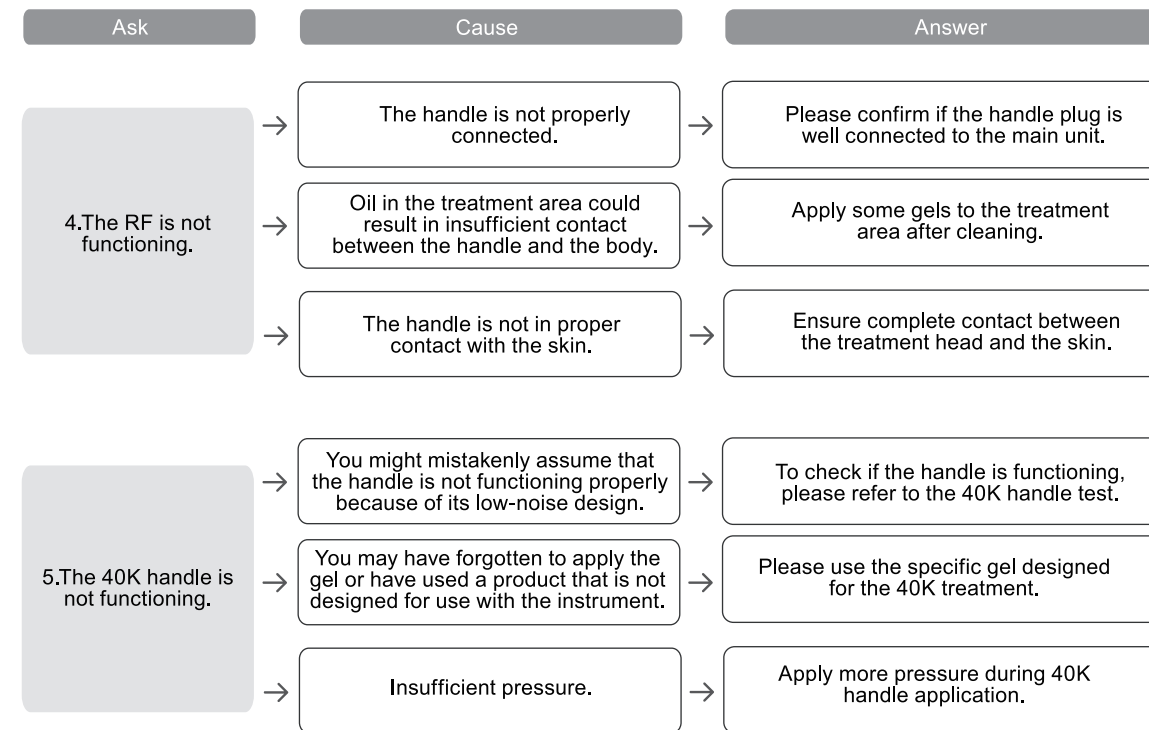
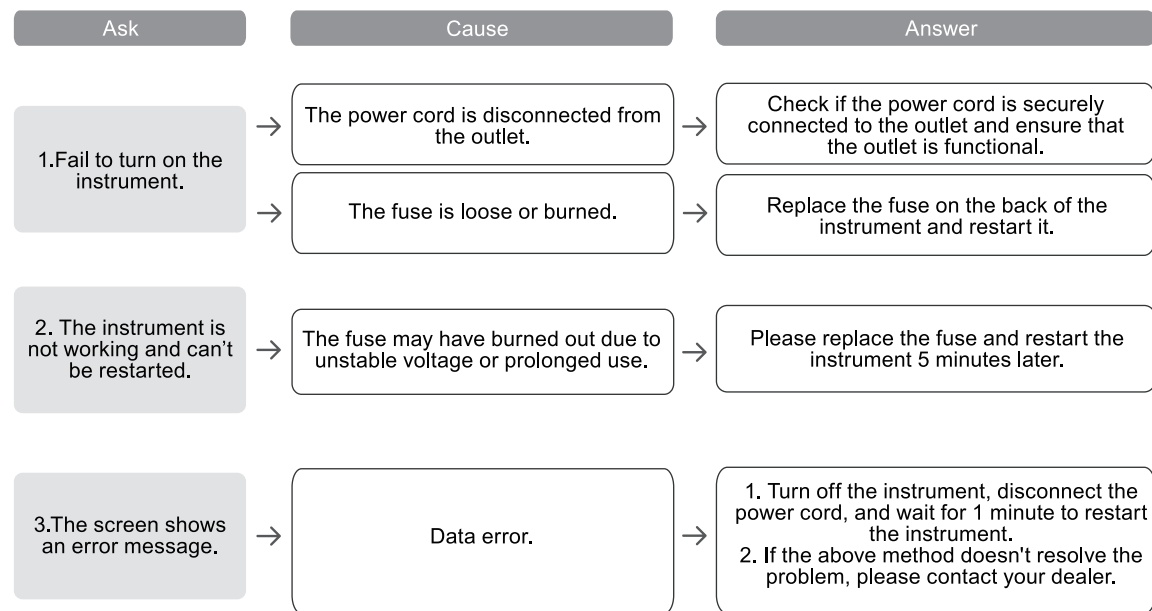

10.Operation Guide

Face:



Step 1: (10 minutes)



Step 2: (7 minutes)



Step 3: (5 minutes)

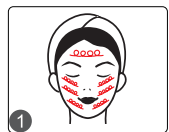

Step 4: (20 minutes)

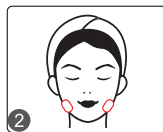

Eye:



Step 1: (10 minutes)



Arm:



Step 1: (15minutes)



Step 2: (15 minutes)



Step 3: (15 minutes)

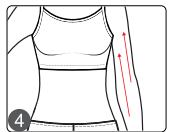
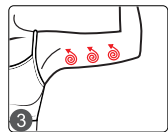
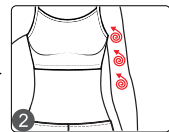

Step 4: (20 minutes)



Belly:



Step 1: (15 minutes)



Step 2: (15 minutes)



Step 3: (15 minutes)

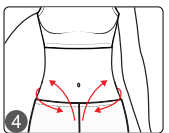
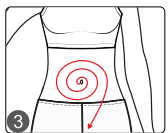
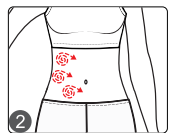
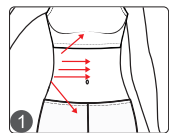

Step 4: (20 minutes)

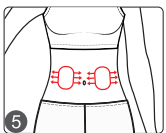

Back:



Step 1: (15 minutes)



Step 2: (15 minutes)

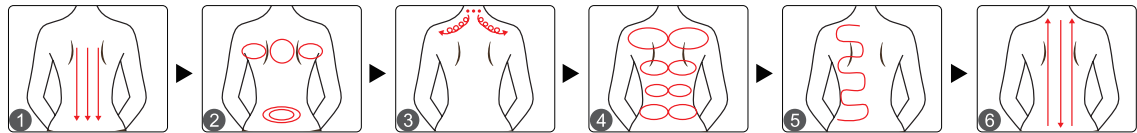

Leg:



Step 1: (15 minutes)



Step 2: (15 minutes)



Step 3: (15 minutes)

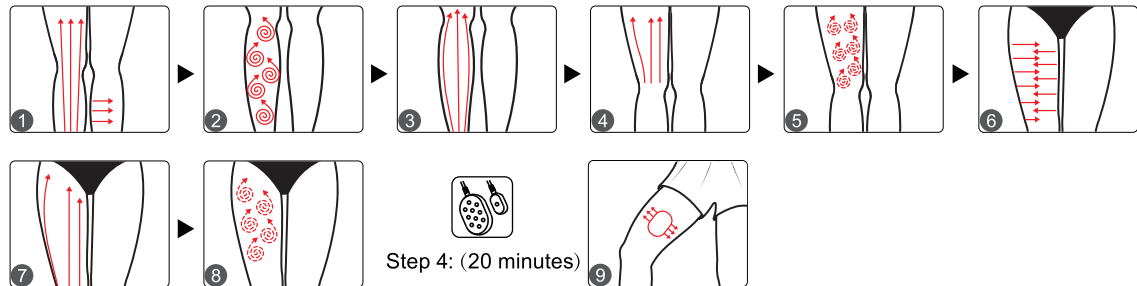

11. Warranty & Support

We provide a one-year warranty and a one-month return and replacement policy from the date of purchase.

Product Name: Versatile Beauty Enhancer

Product Model: MS-22S9SB

Production

Date: _____

Quality

Inspection: _____

PASS